

Air Operated 1:1 Oil Ratio Pump

OP-11

Congratulations on purchase of this World Class Air Operated Oil Ratio Pump !

- World-class Industrial Oil Dispensing pumps with guaranteed performance & hassle free operation
- Used as transfer pumps to quickly transfer oils from large drums to smaller containers. Pumps are designed to work in tough conditions & are ideal for use with low to medium viscosity oils (up to SAE 80) for transferring over short distances (up to 5 metres).
- All metal construction, fully CNC machined with hardened wear resistant moving parts
- Reciprocating piston operated 2-1/2" (63 mm) dia. Air Motor
- Stub Pumps are supplied with Non Return Valve threaded 1" (F) for use on the bottom of the Suction Tube. Other pump lengths have a built in Strainer at pump inlet to keep contaminants away
- Pumps are double acting with discharge up to 40 LPM (10.58 GPM). Air Consumption is 270 LPM (71.5 GPM)
- Also available complete with Oil bar tap & connecting links (ODS series, used as an Air Operated Oil Dispenser to quickly & conveniently dispense Oils from Drums.
- Available in four different versions - Stub, 16 Gal, 55 Gal & ODS version

**Stub Version
OP/S/11B**



**16 Gal Version
OP/T2/11B**

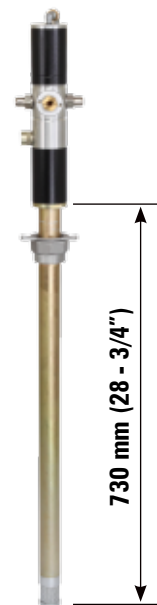

**55 Gal Version
OP/T3/11B**

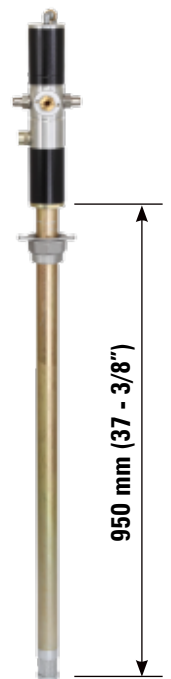

Fig. 1

**ODS Version
ODS/T3/11B**



PUMP CONSTITUENTS

1. Pump Assembly
2. Bung Nut
3. Oil Bar Tap with connecting links (Only in ODS Version)

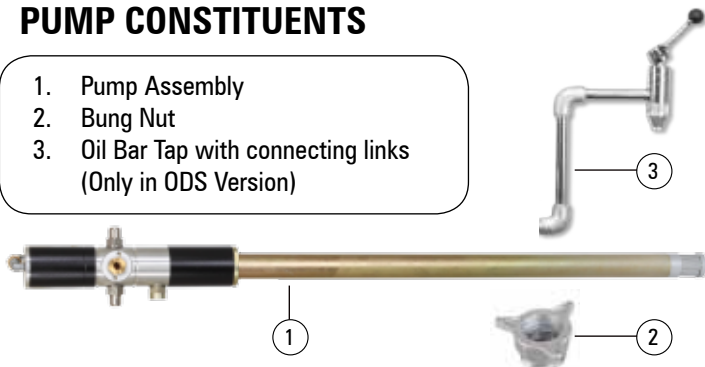

Contents

Page No.

PUMP CONSTITUENTS	1
PUMP CONSTRUCTION	3
GETTING STARTED	3
PUMP INSTALLATION & OPERATION	3
MAINTENANCE & REPAIR	4-8
• Repair Kit Replacement	5-8
EXPLODED VIEW	9
PARTS LIST	10-11
TROUBLESHOOTING	12
REPLACEMENT & SERVICE PARTS PROGRAM	13-15
• Replacement Parts Program	13
• Service Parts Program	14-15
SPECIFICATIONS	16
WARNINGS	16

PUMP CONSTRUCTION

Fig. 2

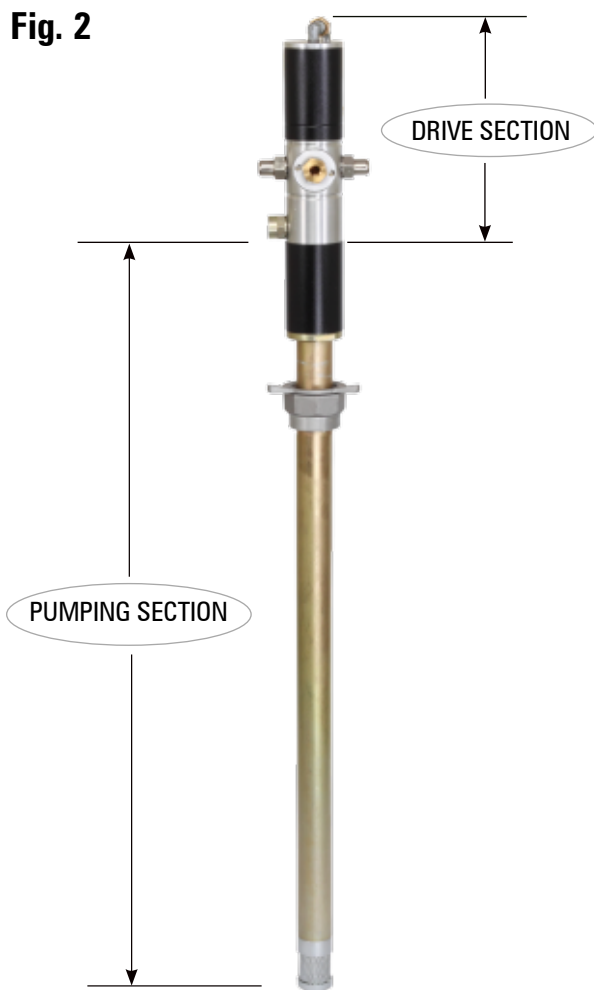

The pump is made up of two sections as below :-

- **DRIVE SECTION:-** It consists of an Air Motor Assembly driven by compressed air. The piston diameter of the air motor is 2.5" / 63 mm. The motor consists of an air cylinder with piston and one reciprocal valve with a nylon slider. The valve directs the compressed air alternately to the top or bottom of the piston, thus producing a reciprocating motion of the piston rod.
- **PUMPING SECTION:-** It consists of a pump in which a piston lifts media through Non Return Valves by reciprocating inside the suction tube. Media is discharged with pressure (from the outlet located at bottom of Air Motor) into the delivery hose / pipe.

NOTE

- **AIR MOTOR** of this pump starts automatically when the dispensing gun / tap is opened. When the dispensing gun / tap is closed, air motor builds up a back-pressure and stops operating the pumping section.
- **PRESSURE RATIO** of the pump states the ratio of the output fluid pressure to the incoming air pressure. Since the pressure ratio is 1:1, we achieve an output media pressure up to 150 PSI (10 BAR) when the incoming air pressure is 150 PSI (10 BAR).

GETTING STARTED

Before installing the pump, make sure the following are available:

- **AIR SUPPLY:** An FRL (Filter-Regulator-Lubricator) unit must be used in the Air supply, before it is connected to the pump.
Set the regulator to 6 BAR (90 PSI) or any required inlet pressure, but never more than 150 PSI (10 BAR) or less than 30 PSI (2 BAR).
When not in use & at the end of each day, air supply to the pump must be switched off.
- **DISCHARGE HOSE:** It is recommended to use a hose with ½" I.D., with a Working Pressure of not less than 400 PSI (28 BAR). Burst Pressure must be atleast 1000 PSI (70 BAR) or more. Using a smaller I.D. hose will cause higher pressure loss.
- **DISPENSING GUN:** Based on the application, you may use a gun that is compatible with media being dispensed.
- **THREAD SEALANT:** Apply thread sealant on all threaded connections to ensure leak-proof operation.

PUMP INSTALLATION & OPERATION

1. Slide out the Bung from Suction Tube & screw it into the 2" opening on the drum.
2. Loosen the ring nut on Bung & carefully insert the pump Suction Tube through it. Once the Suction Tube touches the bottom of drum, tighten the ring nut.
3. Connect the appropriate hose and dispensing gun to the pump outlet. Use a thread sealant to avoid any leakage.
4. With the air supply turned off, connect the air line into the air inlet on the pump. Remove the vent plug on drum to create the required venting for pump operation.
5. Partially open the on/off air valve (It helps in creating initial vacuum when filling a totally dry pump). Pump will start operating automatically until it gets primed. Pump is said to be **Primed** when media is available at the pump outlet, making the pump ready to use. Once primed, the air motor will stop. Open the on/off air valve fully.
6. Operate the dispensing gun / Oil Bar Tap, which will actuate the air motor & pump will start dispensing.

MAINTENANCE & REPAIR

(Refer to Exploded View - Page 9)

General Precautions

- Before performing any service operation, always shut off the air supply and release the system pressure i.e. let the media out so that the pressure decreases. When storing the pump assembly out of the drum, cover the Filter Tube (71) with Filter Cap (72).
 - Be careful not to damage any parts when dismantling. While removing shafts which do not have key flats, use a Pipe wrench, Strap wrench or the like. The easiest way to remove such a shaft is to grip it in a vice with aluminium or copper jaws, clamp the shaft in a hand-drill chuck and then turn the chuck by hand.
 - Be careful when fitting O-rings and seals. Always lubricate them with oil before fitting. They must never be threaded over sharp edges when being fitted. Lubricate all moving parts with oil.
 - When troubleshooting, be on a lookout for dirt in valves / ball seats, scratches in sealing surfaces & damage in O-rings / seals / gaskets.
-

Recommended Tools



A Soft - Jaw vice
(Aluminum or Copper Jaws)



Threaded Pipe
1/2" (M)



Adjustable Caliper Wrench



Wide Jaw Plumbing Plier



Combination Wrench
Size 10, 13, 21, 25 & 28 mm



Phillips Screwdriver



Long Nose Plier
Length = 5.5" - 8"



Tweezer



Soft Faced Plastic Mallet



Ball Pein Hammer

Repair Kit Replacement (Refer to Table 4 - Page 15)

1. Pull out Filter Cap (72) by hand. Hold Barrel (67) in a soft-jaw vice. Tighten a 1/2" male threaded pipe into the outlet adapter (33) & unscrew anticlockwise to remove Air Motor Assembly.

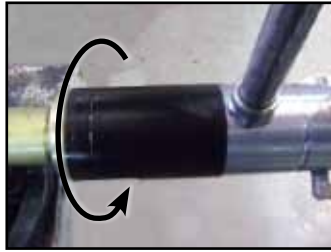

2. Tap around Body (63) with a plastic mallet. Hold Body (63) in soft-jaw vice at the two flats. Unscrew Lower Cylinder (59) anticlockwise to disconnect Body (63) from rest of the Air Motor Assembly.

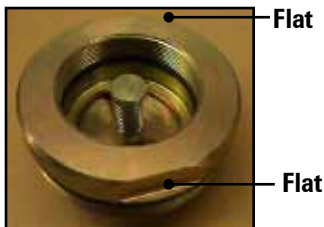

3. Tap around Lower Cylinder (59) with a plastic mallet. Hold Housing (39) in soft-jaw vice. Unscrew Lower Cylinder (59) anticlockwise & pull it out to disconnect it from the piston assembly.

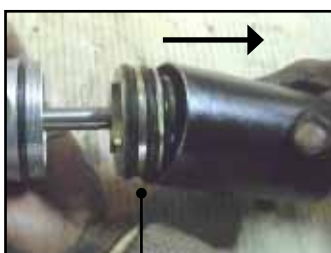

Piston Assembly

4. Hold a nose plier into the pin holes of Non Return (58) and turn the Piston Rod (49) anticlockwise by gripping the flats with a wrench (size 10 mm).



5. Hold Cylinder (7) of Air Motor Assembly in a soft-jaw vice. Unscrew Exhaust valve (35) with a wide jaw plier. Remove Circlip (38) & Filter-B (36) to remove O Ring (37).



Exhaust Valve

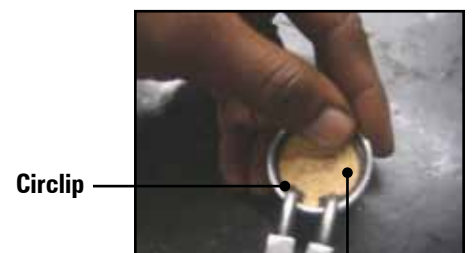

Filter B

6. Loosen both Coupling Nuts (2) using wrench (size 21 mm).



7. Remove Bend Pipe (1) along with both Coupling Nuts (2) & Sealing Rings (3).



8. Unscrew both Bends (4) using wrench (size 13 mm).



9. Lightly tap Cylinder (7) with a plastic hammer & unscrew it .



10. Unscrew Inlet Cover Adapter (31) using wrench (size 25 mm).



11. Connect a caliper wrench into the holes on inlet Cover (29). Unscrew it anticlockwise.

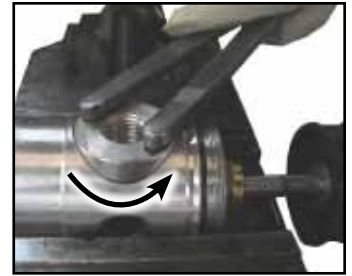

12. Unscrew both Pushers (19) using wrench (size 25 mm) or a pneumatic wrench with 25 mm socket.

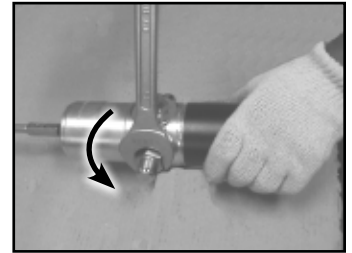

13. Remove both Pushers (19), Springs (17), Pusher Nuts (16) & Pusher Buttons (15).



Pusher Button

14. Using two wrenches (size 10 mm), hold Piston Rod (49) & turn Plunger Rod (11) anticlockwise to disconnect it from Slider Rod (27). Remove Plunger (9) along with Plunger Rod (11). Remove Piston Rod (49) & Slider Rod (27).



Plunger

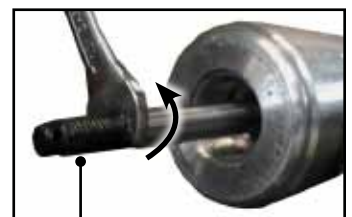

Piston Rod

On removal, Slider Rod (27) is still connected either to Plunger Rod (11) or Piston Rod (49). In either case, hold Slider Rod (27) in a vice & unscrew the other rod with wrench (size 10 mm).

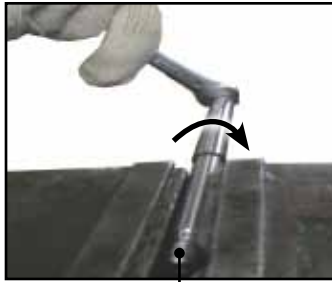

Slider Rod

18. Remove Slider Guide (22).



Slider Guide

15. Remove Slider (26) with a tweezer.



Slider

19. Remove Seat (21) & Paper Seal (20). Clean the bottom surface thoroughly.



Seat & Paper Seal

16. Open the two Screws (18) with a Philips screwdriver & remove Clip (17).



20. Unscrew Seal Body (41) anticlockwise using pneumatic wrench with a 28 mm socket.



Slider

17. Use a Tweezer & remove Nylon Slider (23).



21. Replace the Repair Kits as mentioned in Table 4 - Page 15, by following the steps 1-20 in reverse order taking care of the points below:

- **Ensure all mating surfaces are clean before reassembly. Apply minor oil on all mating surfaces, O Rings & moving parts before reassembly.**



Apply oil on paper seal



- **Ensure that height of Nylon Slider (23) is approx. 5.3 - 5.7 mm. Also, hollow portion of Nylon Slider should rest evenly on top of Seat (21).**

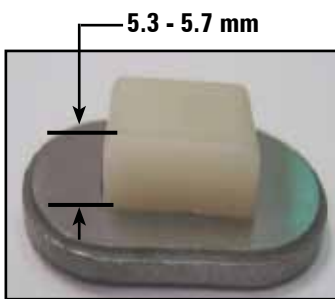

- **When fitting Pushers (19), see through Inlet Cover (29) & ensure Pusher Buttons (15) are installed in centre position. Also ensure that Clip (24) is tight & Nylon Slider (23) moves smoothly.**



- **When fitting, apply locking fluid on threads of Bends (4), Slider Rod (27), Seal Body (41), Non Return (58) & Barrel (58) to avoid any leakage.**



- **While replacing Repair Kit (KIT/PST/T3/11B), note that Piston Assembly comes already assembled with Lower Cylinder (59). Hence, assemble this kit as below:**

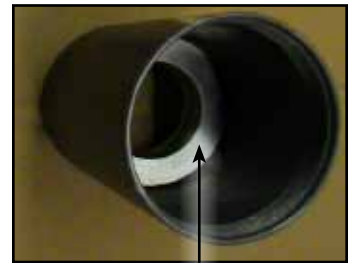

Piston Assembly

- Fully tighten Slider Rod (27) into Piston Rod (49) using locking fluid & insert from bottom of Housing (39). Using two wrenches of size 10 mm, hold Plunger Rod (11) & tighten Piston Rod (49) clockwise.

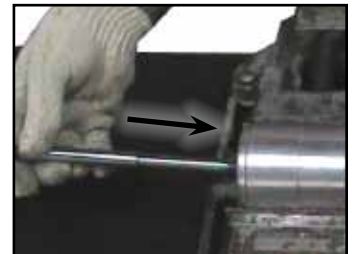

- Flat portion of Pusher (50) should face the threads on Piston Rod (49). Lower Cylinder (59) should be placed on Pusher (50).



Piston Rod

Pusher



- Hold Piston Rod (49) with wrench (size 10 mm) & tighten Non Return (58) clockwise with a long nose plier (Length - 5.5 - 8")



EXPLODED VIEW

Fig. 3

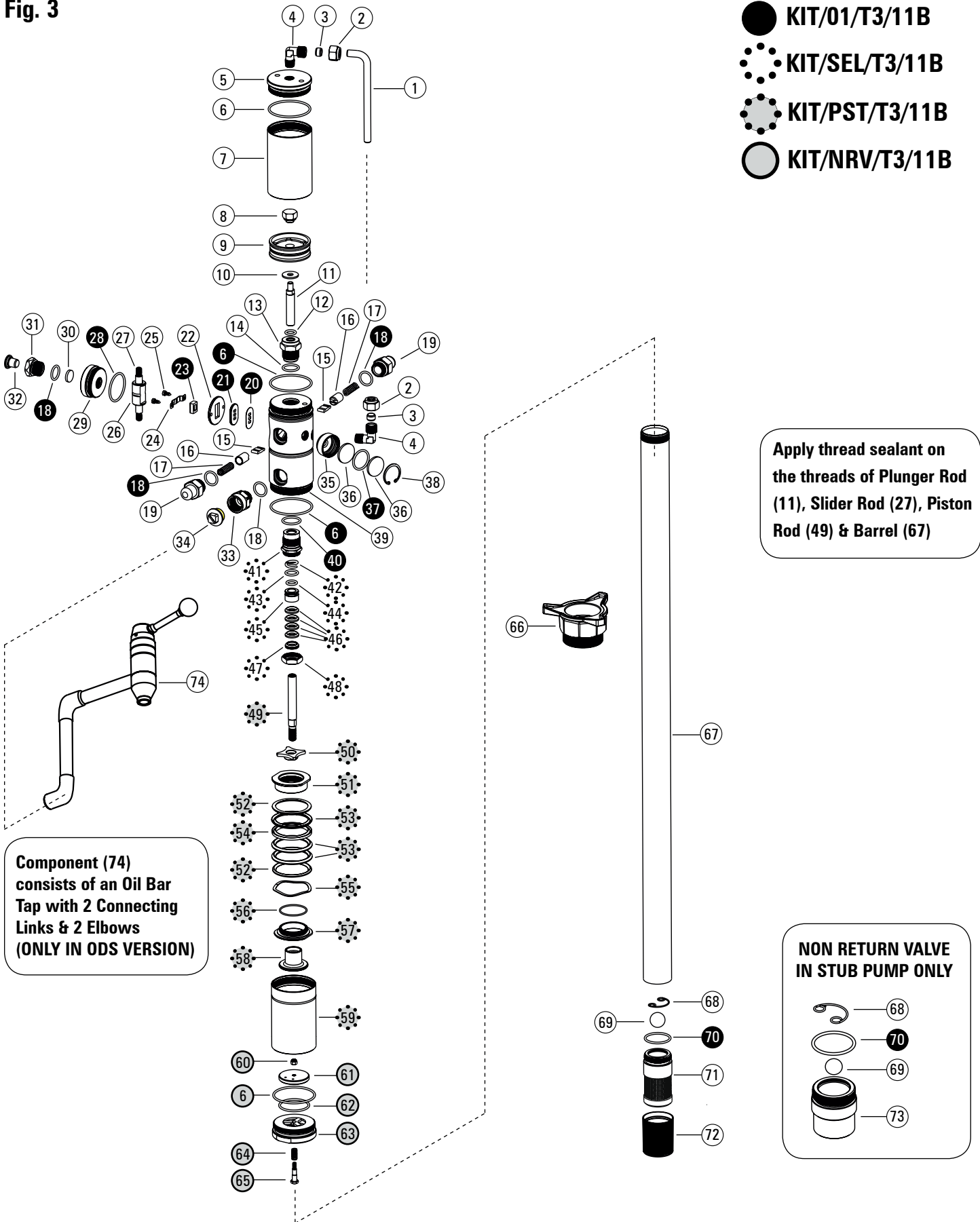

PARTS LIST**Table 1**

REFERENCE NO. FROM EXPLODED VIEW	DESCRIPTION	QUANTITY
1	Bend Pipe	1
2	Coupling Nut	2
3	Sealing Ring	2
4	Bend	2
5	Cylinder Cover	1
6	O Ring BS141	3
7	Cylinder	1
8	Plunger Nut	1
9	Rubber Plunger	1
10	Steel Washer	1
11	Plunger Rod	1
12	O Ring BS614	1
13	Rod Guide	1
14	O Ring BS116	1
15	Pusher Button	2
16	Pusher Nut	2
17	Pusher Spring	2
18	O Ring BS617	4
19	Pusher	2
20	Paper Seal	1
21	Seat	1
22	Slider Guide	1
23	Nylon slider	1
24	Clip	1
25	Self Tapping Screw	2
26	Slider	1
27	Slider Rod	1
28	O Ring BS129	1
29	Inlet Cover	1
30	Filter (S)	1
31	Air Inlet Adapter	1
32	Inlet Cap	1
33	Outlet Adapter	1
34	Inlet Cap on Outlet	1
35	Exhaust Valve	1
36	Filter (B)	2
37	O Ring BS121	1
38	Circlip	1
39	Housing	1
40	O Ring BS119	1
41	Seal Body	1
42	Seal Spring	1
43	O Ring BS616	1
44	O Ring BS614	1

REFERENCE NO. FROM EXPLODED VIEW	DESCRIPTION	QUANTITY
45	Spring Holder	1
46	Seal	4
47	Seal Holder	1
48	Seal Nut	1
49	Piston Rod	1
50	Pusher (Piston)	1
51	Seal Holder (Piston)	1
52	Seal Support (Piston)	2
53	Piston Seal	3
54	Seal Support (Middle)	1
55	Wavy Washer	1
56	O Ring BS029	1
57	Adapter (Piston)	1
58	Non Return (Piston)	1
59	Lower Cylinder	1
60	Nyloc Nut	1
61	Non Return	1
62	O Ring BS130	1
63	Body (Non Return Valve)	1
64	Spring (Non Return Valve)	1
65	Bolt (Non Return Valve)	1
66	Bung	1
67	Barrel	1
68	Circlip	1
69	Ball (7/8")	1
70	O Ring BS126	1
71	Filter Tube	1
72	Filter Cap	1
73	Body (For Stub Pump only)	1
74	Oil Bar Tap with Connecting Links	1

TROUBLESHOOTING

(Refer to Exploded View - Page 9)

Table 2

PROBLEM	POSSIBLE CAUSE	SOLUTION
Pump operates, but does not dispense media at all	Media viscosity is too high	Make sure that media used has a viscosity of SAE 80 or lower
	Drum is Empty	Media level inside the drum may be too low. Refill drum
	Pump inlet is blocked	Remove suction tube & clean strainer at pump inlet
	Air Inlet Pressure is too less	Increase air pressure. It must be at least 30 PSI (2 BAR)
Pump not working / less discharge	Air Inlet pressure is too less	Increase air pressure. It must be at least 30 PSI (2 BAR)
	Nylon Slider (23) is jammed / overtight	<ol style="list-style-type: none"> 1. Check for any build-up edge on Clip (24) & tighten it again. Make sure the movement of Nylon Slider (23) is neither very loose nor very tight 2. If needed, replace Nylon Slider (23). Also replace the Paper Seal (20) & Seat (21) to ensure the best fitting
	Plunger (9) / Plunger Rod (11) / Piston Rod (49) / Seal Holder (51) jammed.	<ol style="list-style-type: none"> 1. Disconnect Air Motor Assembly from the Barrel (67) 2. Supply input air to Air Motor. If it works properly without the barrel assembly, then the problem lies with the pumping section. Otherwise check the Air Motor for smooth movement 3. After locating the faulty section, check the respective Piston / Plunger & the associated washers & seals for any overlap or wear & tear. Replace the defective parts from Repair Kit 4. Ensure to replace the moving parts having close tolerances (such as Nylon Slider (23), Paper Seal (20) & Seat (21) as a SET to ensure the best fitting
Pump continues to operate even after releasing the trigger of dispensing gun or after shutting off Oil Bar Tap	Air Leakage in the pump assembly	<p>Check all the connections to ensure they are air tight. Use thread sealant.</p> <p>Check O rings & seals for damage. Replace the defective parts from Repair Kit</p>
Media comes through the air Exhaust Valve (35)	Media leaks into the Air Motor	Check O Ring (44) and Seals (46). If worn out, replace the Seal Kit- KIT/SEL/T3/11B (Ref. Table 4 on Page 15)
Air passes directly from inlet to the outlet & pump does not work	Nylon Slider (23) is jammed / overtight	<ol style="list-style-type: none"> 1. Check for any build-up edge on Clip (24) & tighten it again. Make sure the movement of Nylon Slider (23) is neither very loose nor very tight 2. If needed, replace Nylon Slider (23). Also replace the Paper Seal (20) & Seat (21) to ensure the best fitting
Discharge suddenly stopped while the pump was running	Seals / O Rings Damage	Check all seals / O Rings & replace the damaged parts from Repair Kit
	Chip / Other foreign particles get clogged at dispensing gun / discharge outlet	Clean all foreign particles / chips
	Clogging of Filter Tube (71) / Non Return Valve Body (73)	Open, clean it & reassemble it properly

REPLACEMENT & SERVICE PARTS PROGRAM
(Refer to Exploded View - Page 9)

REPLACEMENT PARTS PROGRAM

Table 3

REFERENCE NO. FROM EXPLODED VIEW	PART NO.	DESCRIPTION	QUANTITY
66	BUNG/OP/42	Bung	1
74	KIT/ODS	Oil Bar Tap with Connecting Links	1

SERVICE PARTS PROGRAM

Fig. 4

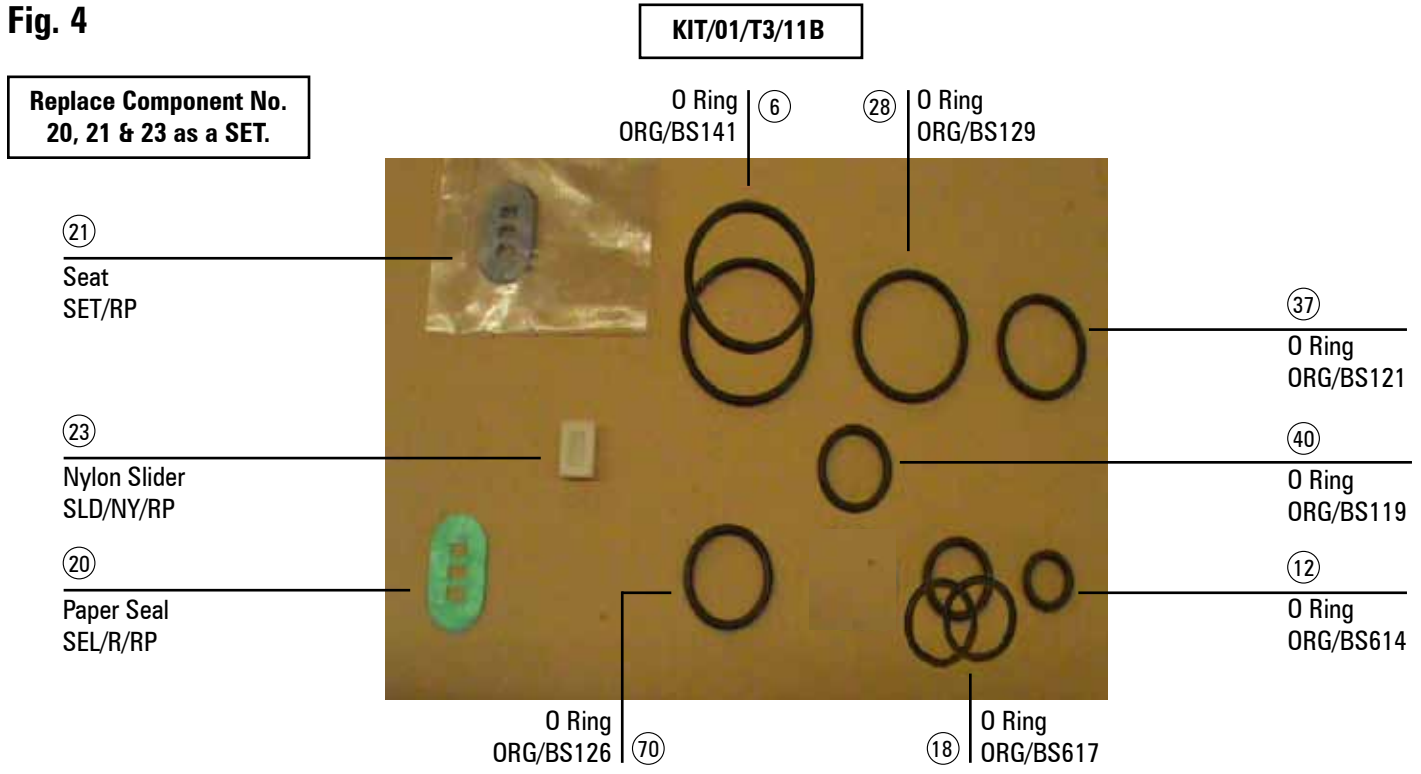

Fig. 5



Fig. 6

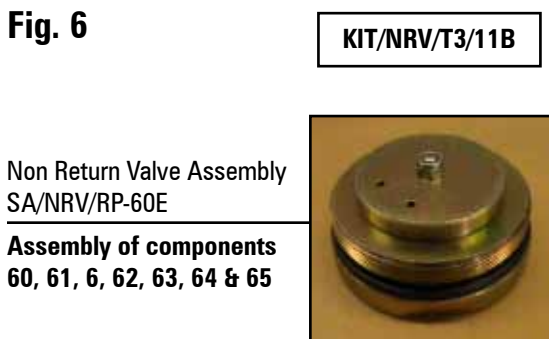
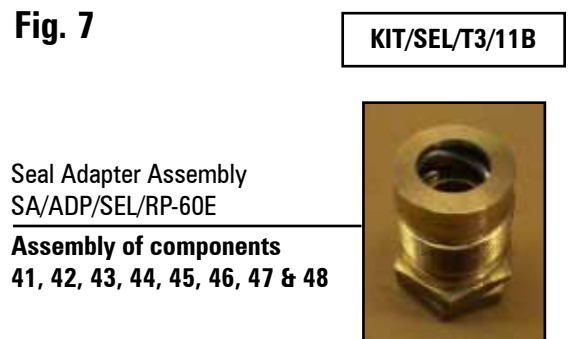

Fig. 7



SERVICE PARTS PROGRAM

Table 4

KIT PART NO.	KIT DESCRIPTION	CONSTITUENT NO.	PART DESCRIPTION	REF. NO.	QTY PER KIT	SUPPLY CONDITION
KIT/01/T3/11B	AIR MOTOR KIT	SET/RP	Seat	21	1	AS SET
		SEL/P/RP	Paper Seal	20	1	
		SLD/NY/RP	Nylon Slider	23	1	
		ORG/BS617	O Ring	18	3	
		ORG/BS614	O Ring	12	1	
		ORG/BS141	O Ring	6	2	
		ORG/BS129	O Ring	28	1	
		ORG/BS126	O Ring	70	1	
		ORG/BS121	O Ring	37	1	
		ORG/BS119	O Ring	40	1	
KIT/SEL/T3/11B	SEAL KIT	SA/ADP/SEL/RP-60E	Seal Adapter Assembly	N/A	1	ASSEMBLED
KIT/PST/T3/11B	PISTON KIT	CYL/RP-60E/BL	Cylinder	59	1	ASSEMBLED
		SH/PST/RP-60E	Seal Holder	51	1	
		SSU/PST/RP-60E	Seal Support (Piston)	52	2	
		SEL/PST/RP-60E	Seal (Piston)	53	3	
		SSU/PST/MID/RP-60E	Seal Support (Middle)	54	1	
		WWSR/PST/RP-60E	Wavy Washer	56	1	
		ORG/BS029	O Ring	56	1	
		ADP/PST/RP-60E	Adapter (Piston)	57	1	
		ROD/PST/RP-60E	Piston Rod	49	1	AS SET
		PSH/PST/RP-60E	Pusher	50	1	
		NR/PST/RP-60E	Non Return Piston	58	1	
KIT/NRV/T3/11B	NON RETURN VALVE KIT	SA/NRV/RP-60E	Non Return Valve Assembly	N/A	1	ASSEMBLED

SPECIFICATIONS*

Table 5

Flow Rate	Up to 40 LPM (10.58 GPM)
Working Pressure	2-10 BAR (30-150 PSI)
Maximum Air Inlet Pressure	10 BAR (150 PSI)
Maximum Media Outlet Pressure	10 BAR (150 PSI)
Air Inlet Connection	1/4" (F)
Pump Inlet on Stub Pumps only	1" (F)
Pump Outlet Connection	1/2" (F)
Air Consumption	270 LPM (71.5 GPM)
Noise Level	81 db

* Pump is available in three different versions - Stub, 16 Gal, 55 Gal & ODS version

WARNING

- Always wear protection gear like safety goggles, gloves, apron, and ear plugs while operating the pump
- Never let any body part come in front of, or in contact with the control outlet
- Always cut off air supply after use, so that media cannot leak in case any of the pump component fails
- Before switching the air supply on, check hoses for any sign of wear, leak or loose fittings. Replace as necessary
- Do not smoke near the pump. Do not use the pump near a source of spark / open flames
- When changing the working fluid, at least 1 litre of new fluid should be discarded to avoid mixing of fluids
- Pump should NOT be operated for more than 4 hrs continuously
- Pump must be supplied with CLEAN & DRY compressed air via an FRL unit
- Before attempting any maintenance or repair of this product, disconnect air supply and then operate dispensing gun to release fluid pressure
- Use only genuine factory parts for repair

WETTED COMPONENTS

Steel, Brass, Aluminum, Hi Nitrile Rubber, Polyurethane, Nylon

RECOMMENDED USE

ATF, Engine Oil, Gear Oil, Hydraulic Oil, low to medium viscosity oils (up to SAE 80), Diesel, Kerosene

DO NOT USE WITH

Corrosive Fluids, Solvents, Acid, Alkalis, Antifreeze, waste oil or any other media not compatible with the pump components



Groz Engineering Tools (P) Ltd.
Groz Net Industries

Village Kherki Daula, National Highway-8
Gurgaon-122001, Haryana, INDIA
TEL +91.124.282.7700 / 221.4050
FAX +91.124.2827986 / 221.4224
FAX (USA) +1.509.271.7848
FAX (UK) +44.870.121.1854

E-MAIL info@groz-tools.com
URL www.groz-tools.com

The Groz name, Groz logo and the  mark are trademarks of Groz Engineering Tools (P) Ltd. India