

Electric Diesel Pump

EDP/12, EDP/24



Congratulations on purchase of this World Class Electric Diesel Pump !

- Portable Diesel transfer pumps designed for everyday use in Agricultural, Construction, Automotive & Industrial applications
- Lightweight, yet strong non corroding Aluminum Die Cast Construction
- Self priming Vane pump design
- Duty Cycle: 30 Minutes On / 30 Minutes Off
- Available in a choice of 12V or 24V in two styles:
 1. Base Plate Style
 2. Drum Mount Style
- Delivery nozzle comes in a choice of Manual / Automatic



BASE PLATE STYLE

- Includes Pump with Base Plate, Lift Handle, Strainer, 2m long Battery Cable with fuse & clamps. Aluminum Nozzle
- Pump inlet & outlet threaded 3/4" (F)
- Supplied complete with 4m x 3/4" ID hose that can be cut into two parts for use as a suction & delivery hose
- Hardware supplied includes 3 hose barbs (3/4") & 4 hose clamps

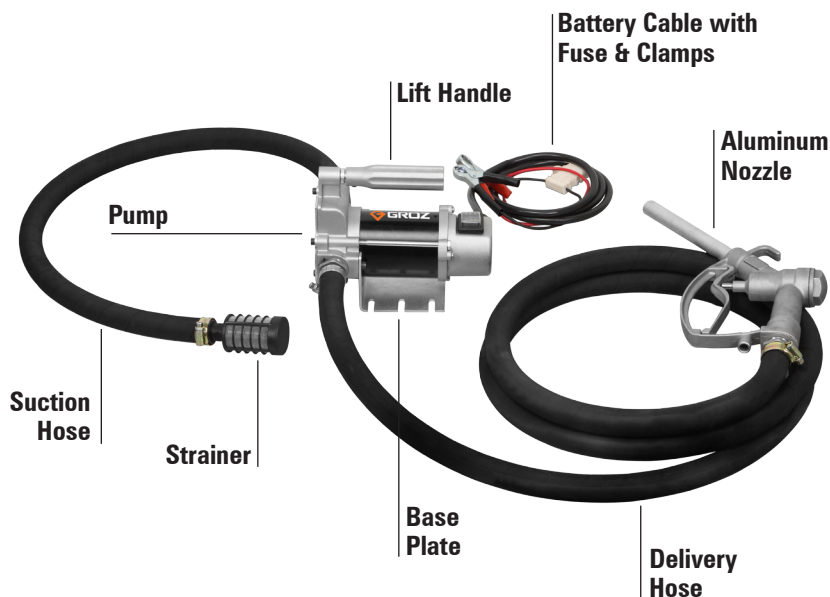

DRUM MOUNT STYLE

- Includes Pump with 2" Bung, Elbow Fitting, 2 pc threaded steel Suction tube & Nozzle Holder, 2m long Battery Cable with fuse & clamps. Aluminum Nozzle
- Pump Inlet threaded 1"(F) & outlet threaded 3/4" (F)
- Supplied complete with 3m x 3/4" ID delivery hose
- Hardware supplied includes 2 hose barbs (3/4") & 2 hose clamps

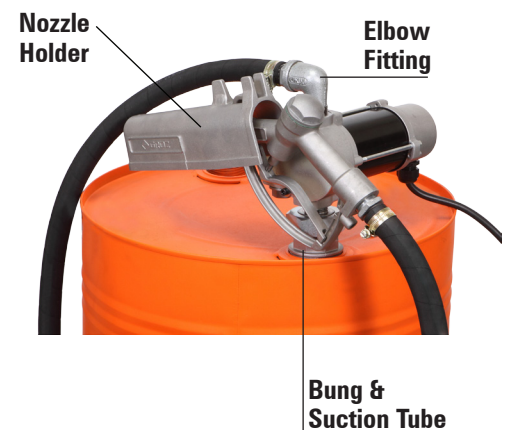

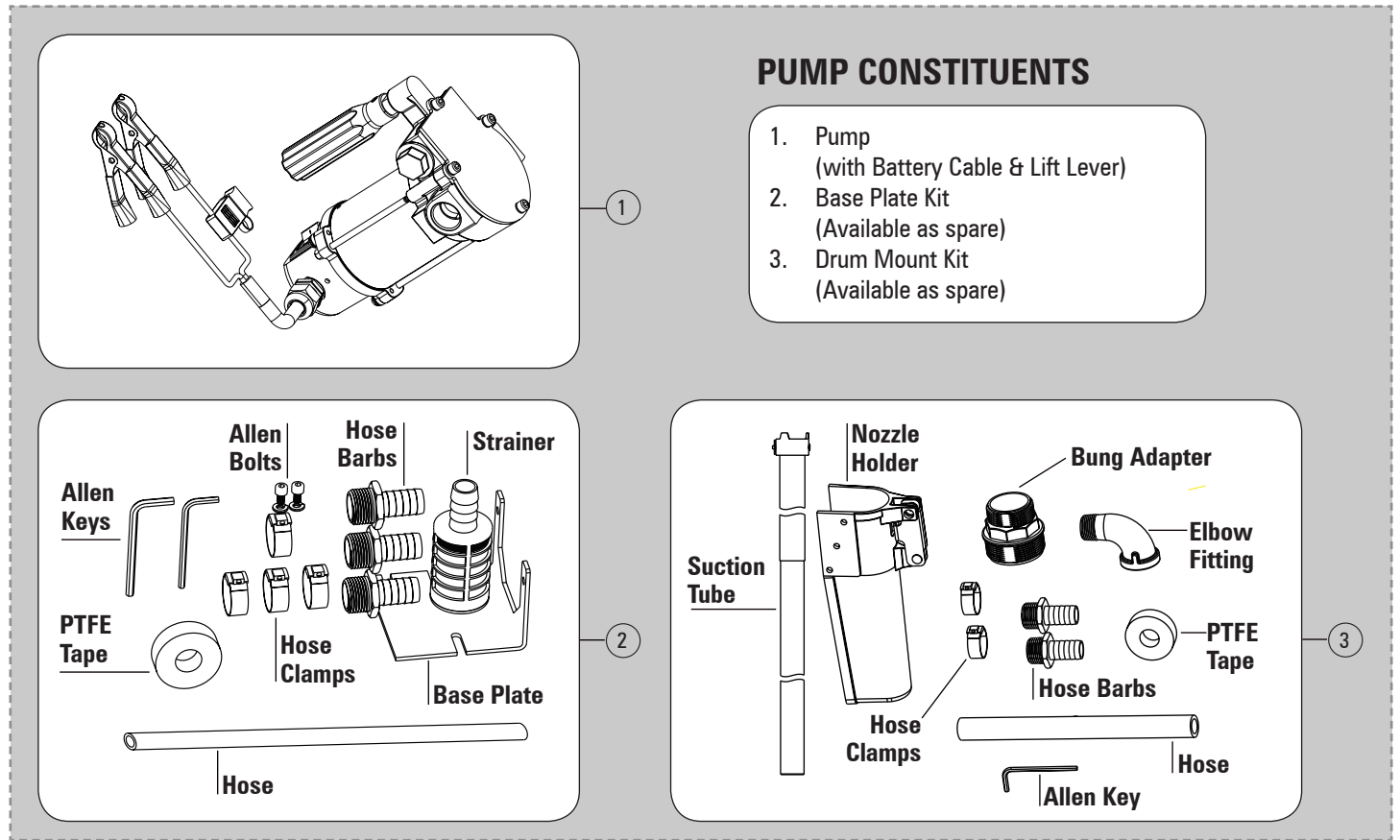

PUMP WORKING

This is a Vane Type Pump driven by an electric motor. A slotted rotor (carrying five vanes) is eccentrically supported in a cycloidal housing forming a crescent-shaped cavity.

When the motor starts, the rotor, being attached to the armature shaft with a key, starts rotating. As the shaft reaches 2600 RPM, centrifugal force & hydraulic pressure push the vanes to the walls of the housing. It generates sufficient suction to draw fluid into the pumping chamber through inlet port. Fluid enters the pockets created by vanes, rotor and cover plate.

As the rotor continues to rotate, the vanes sweep the fluid to the opposite side of the crescent where it is squeezed through outlet port into the delivery hose.

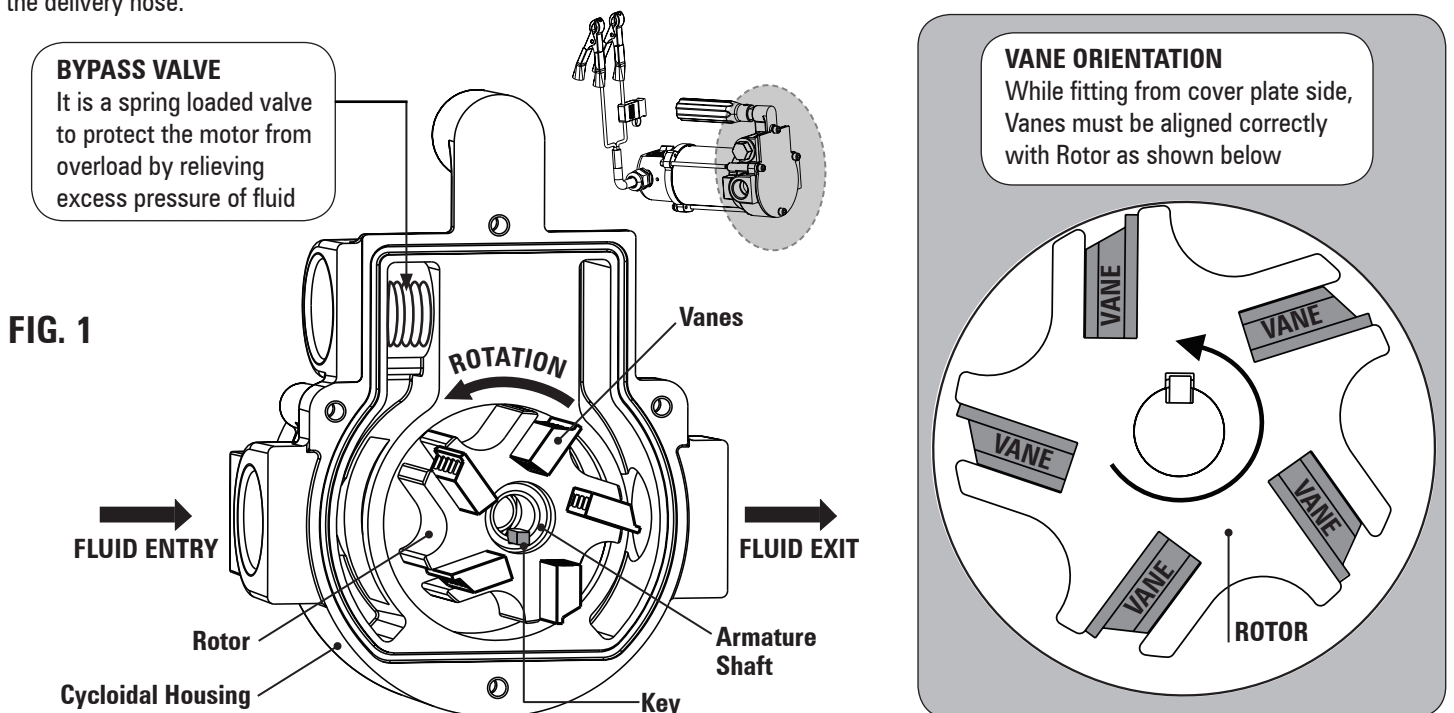

PUMP INSTALLATION (Refer to EXPLODED VIEW - Page 6)

Base Plate Version

1. Fasten the Base Plate (37) firmly near your workplace using suitable bolts. Fix the Base Plate with pump by tightening two Allen Bolts (31) using Allen Key (29) of size 5.
2. Cut the Combo Hose (36) into two parts to make suction & delivery hose of convenient length.
3. Screw a Hose Barb (32) into pump inlet (3/4" female threads) & fix it to suction hose using a Hose Clamp (35). Connect the Strainer (33) to other end of suction hose using another Hose Clamp (35).
4. Fix Hose Barbs (32) at both ends of the delivery hose. Screw one end of the hose into female threads on pump outlet & tighten with a Hose Clamp (35).
5. Screw the Fuel Control Nozzle (28) onto free end of delivery hose & tighten with a Hose Clamp (35).

Drum Mount Version

1. Assemble both sections of the 2 piece Suction Tube (38). Slide the Bung Adaptor (40) onto the top section of Suction Tube (38)
2. Screw the Suction Tube (38) firmly into pump inlet. Lift the pump and insert Suction Tube (38) through the bung opening on the drum. Screw the Bung Adaptor (40) onto the drum to lock the pump firmly into position.
3. Screw the male threads of Elbow Fitting (41) to pump outlet. Fix Hose Barbs (32) at both ends of the Hose (42). Screw one end of the Hose into female threads on Elbow Fitting (41) & tighten with a Hose Clamp (35).
4. Screw the Fuel Control Nozzle (28) onto free end of Hose (42) & tighten with a Hose Clamp (35).
5. Remove two Allen Bolts (1) from Cover Plate (2) using Allen Key (30). Align the Nozzle Holder (39) with Cover Plate & re-tighten the two Allen Bolts.

Caution

- **Always use a thread sealant such as PTFE Tape on all the fluid joints to make them leak-proof**
- **Do not overtighten connections**

ELECTRICAL CONNECTIONS

1. Make sure the Rocker Switch (25) is in "OFF" position.
2. The Battery Cable (26) is secured to the side of Switch Cover (23) with a threaded Plastic Gland (27). Connect the red wire to the positive (+) battery terminal and the black wire to the negative (-) battery terminal.

Caution

- **NEVER use a power source while it is still connected to another circuit (e.g car battery). Disconnect it before using for the pump**
- **The available power source must have the same voltage as the pump voltage (either 12 volt or 24 volt DC, depending on model)**
- **Battery Cable (26) is supplied with 15 Amp Fuse. It can be replaced when needed but only with a fuse of same amperage**

PUMP OPERATION

1. After making the electrical connections, switch ON the pump motor using Rocker Switch (25) located on the side of pump base.
2. Ensure that the open end of suction hose / tube is properly dipped in fuel.
3. Insert the Fuel Control Nozzle (28) into the fuel tank and squeeze the nozzle lever to dispense fuel. A manual nozzle needs manual opening & closing but an automatic nozzle has a sensor built into the discharge spout outlet that automatically shuts off supply once fuel level in the delivery tank reaches that of the spout outlet.
4. The pump will now prime. When discharge is not needed, switch OFF the motor & disconnect Battery Cable (26) from the power supply.

Caution

- **The suction height (from the pump to the lowest fuel level) should not be greater than 1 metre**
- **The tank must be vented or the pump may not prime, or it may lose its prime due to a vacuum in the tank**
- **A filter should be installed at the suction line to ensure a clean supply of fluid to the pump**
- **Do not run pump for more than 5 minutes with nozzle closed. Do not run pump for more than 30 minutes continuously in 1 hour**
- **Do not use a Curb Pump Auto Nozzle with this pump. Use of a Curb Pump Auto Nozzle may cause priming problems, reduced output flow, and motor overheating**

MAINTENANCE & REPAIR (Refer to EXPLODED VIEW - Page 6)

General Precautions

- Switch off the pump motor and disconnect Battery Cable (26) from the power supply before carrying out any maintenance
- Before dismantling the pump, remove it from drum & disconnect it from all the accessories (hose / tube / nozzle holder etc.)
- If the pump has been operated with Fuel Control Nozzle (28) closed, press trigger on the nozzle to release any built up pressure inside the hose or pump
- Be careful when fitting O-rings and seals. Replace them with new ones when they are removed from the pump. Always lubricate them with oil or grease before fitting. They must never be threaded over sharp edges when being fitted

Recommended Tools



Combination Wrench
Size 8 mm, Size 24 mm



Allen Key
Size 4



Slotted Screwdriver

VANE KIT REPLACEMENT (Refer to EXPLODED VIEW - Page 6)

1. Remove four Allen Bolts (1) using Allen Key (size 4). Remove Cover Plate (2), Rubber Washer (3), Vanes (4), Rotor (6) & Key (5) from Housing (12). Replace Vanes (4) if damaged or worn.

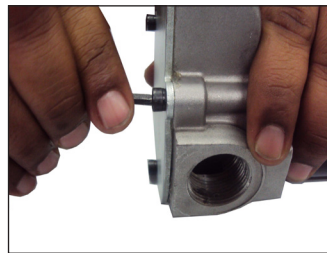

Rotor

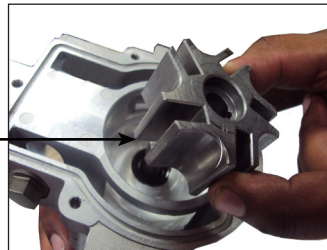

2. Use a wrench and remove the Hex Plug (9). Remove the Valve Spring (10) & Bypass Valve (11). Clean or replace if required.

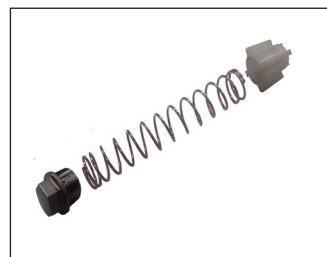

3. Replace Vane Kit (EDP/KIT/VK) by repeating steps 1-2 in reverse order ensuring:

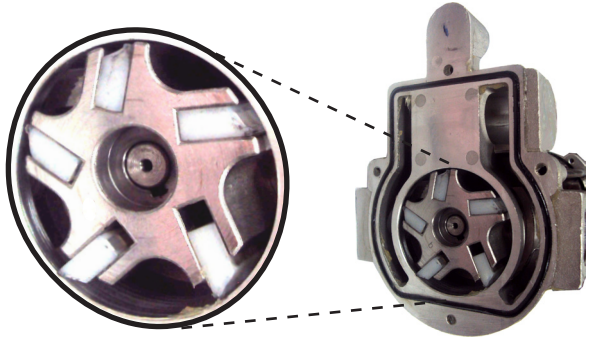
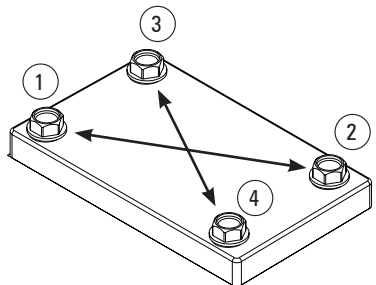
- **CORRECT ORIENTATION OF VANES** as shown in the images here.
- 
- **SMOOTH MOVEMENT OF BYPASS VALVE** against the force of Valve Spring. Do not overtighten Hex Plug (9).
 - Ensure all mating surfaces are clean before reassembly. Apply minor grease on all O-Rings & Seals before reassembly.
 - Always Loosen / Tighten the bolts in an even & diagonal pattern. First tighten all the bolts by hand & finally tighten each bolt by 1 FULL turn using a tool of correct size.
- 

MOTOR KIT REPLACEMENT (Refer to EXPLODED VIEW - Page 6)

1. Loosen three Screws (24) with a slotted head screwdriver.

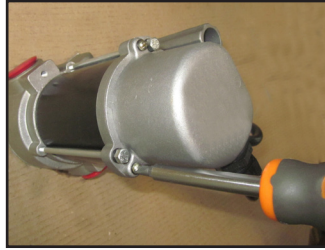

2. Remove Switch Cover (23) & disconnect the couplers attached to it. Also remove Rubber Washer (21) & Rubber Grommet (20).

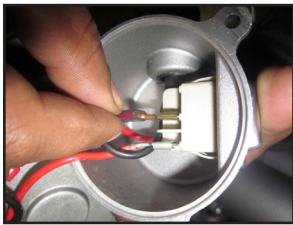

3. Grab the locking clips of Rocker Switch (25) & press from inside to remove the switch.

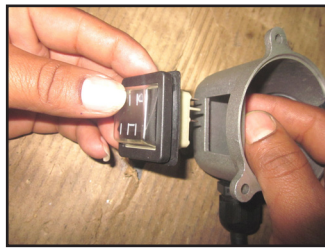

4. Loosen Motor Bolts (22) with 8 mm wrench.

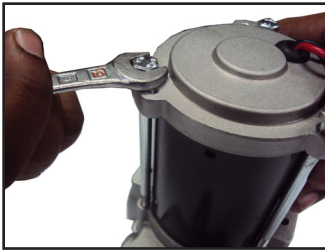

5. Remove Brush Cover (19).

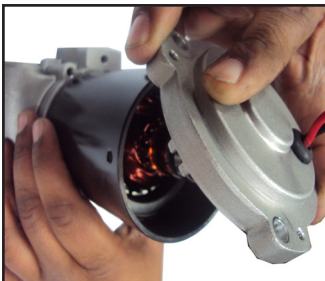
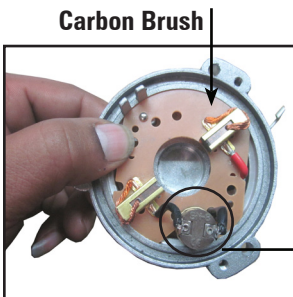

6. Remove four Allen Bolts (1) using Allen Key (size 4). Remove Cover Plate (2), Vanes (4), Rotor (6) & Key (5) from Housing (12).

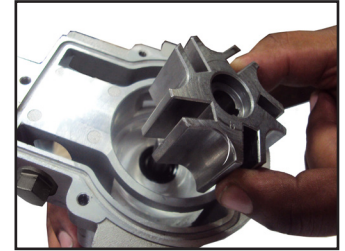
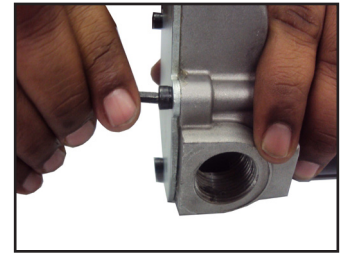

7. Pull the Magnet Assembly (14) & disconnect Armature Assembly (15) from Housing (12).

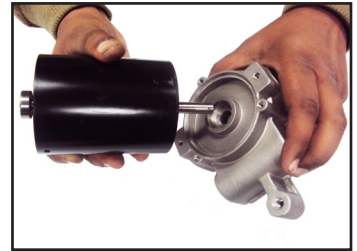

8. Replace Motor kit (**EDP/KIT/MK**) in reverse order ensuring the following points:

- **CORRECT ORIENTATION OF VANES** as shown in Step 2 of section **VANE REPLACEMENT**.
- **CORRECT FITTING OF CARBON BRUSHES:** Align the teeth on Brush Cover (19) with the notch on Magnet Assembly (14).



EXPLODED VIEW FOR ELECTRIC DIESEL PUMP - 12V DC & 24V DC

PUMP ASSEMBLY

FIG. 2

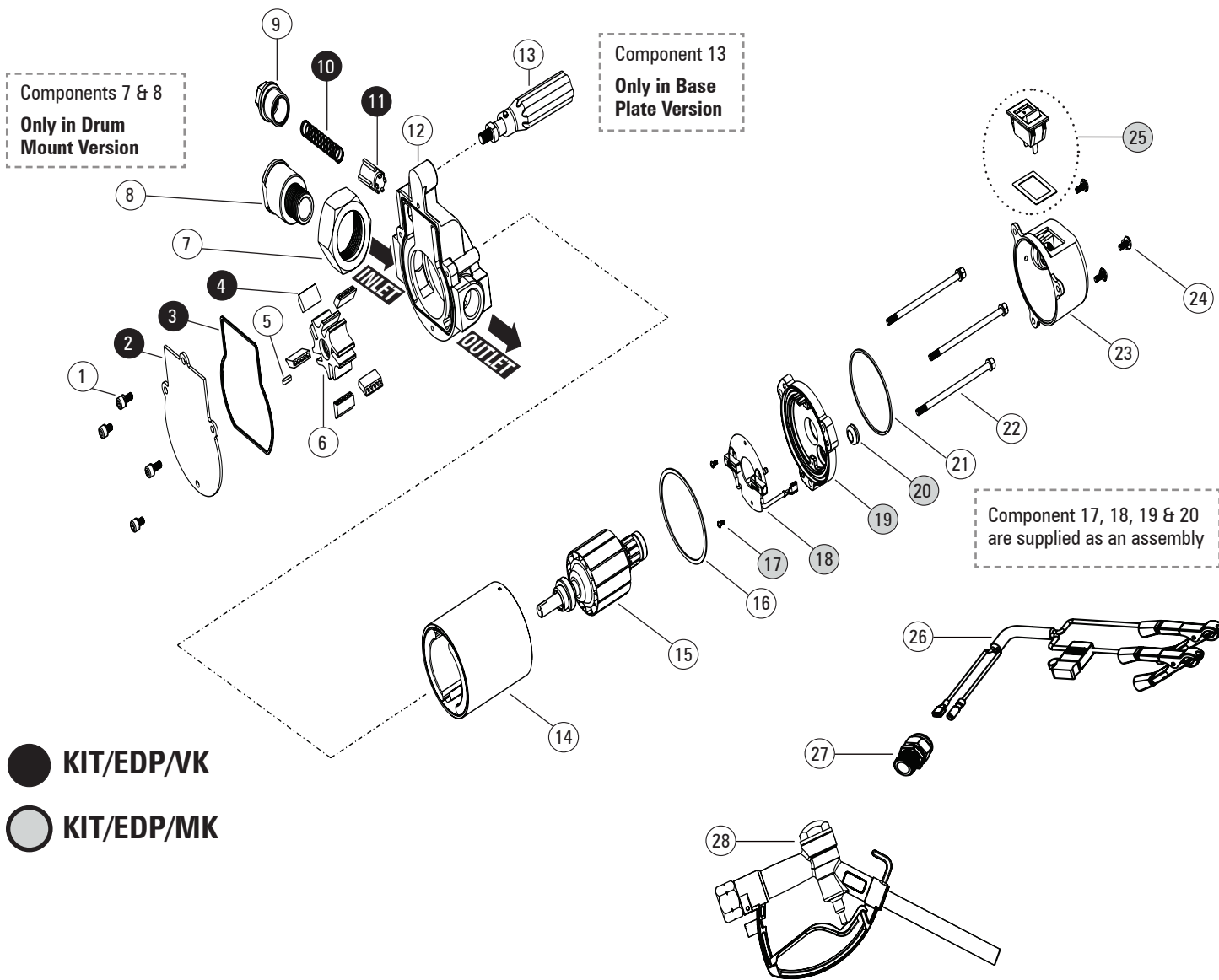

FIG. 3

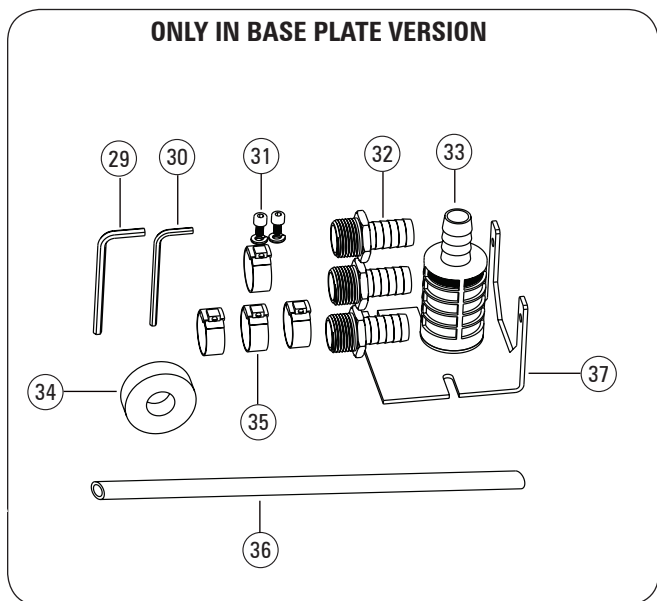
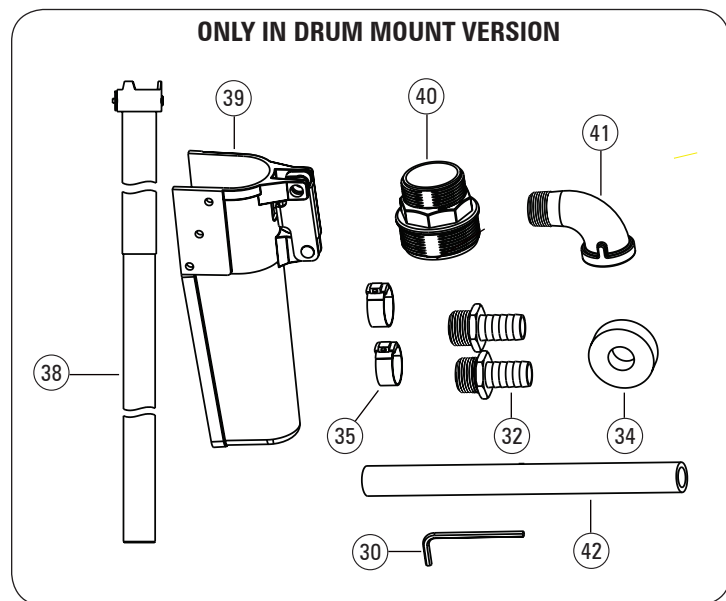

FIG. 4



PARTS LIST FOR ELECTRIC DIESEL PUMP - 12V DC & 24V DC**Table 1****PUMP ASSEMBLY**

REFERENCE NUMBER	DESCRIPTION	QUANTITY
1	Allen Bolt M5	4
2	Cover Plate	1
3	Rubber Washer (Housing)	1
4	Vane	5
5	Key	1
6	Rotor	1
7	Bung Nut (Only for Drum Mount Version)	1
8	Bung Fitting (Only for Drum Mount Version)	2
9	Hex Plug	1
10	Valve Spring	2
11	Bypass Valve	1
12	Housing	1
13	Handle (Only for Base Plate Version)	1
14	Magnet Assembly	1
15	Armature Assembly	1
16	Rubber Washer (Front)	1
17	Thread Forming Screw	2
18	Carbon Brush Assembly	1
19	Brush Cover	1
20	Rubber Grommet	1
21	Rubber Washer (Rear)	1
22	Motor Bolt	3
23	Switch Cover	1
24	Philipps Head Screw	3
25	Rocker Switch	1

BATTERY CABLE, FUEL CONTROL NOZZLE, HOSE & OTHER ACCESSORIES**Table 2**

26	Battery Cable	1
27	Plastic Gland	1
28	Fuel Control Nozzle (Manual)	1
29	Allen Key (Size 5)	2
30	Allen Key (Size 4)	1
31	Allen Bolt M6	2
32	Hose Barb (For Base Plate Version)	3
	Hose Barb (For Drum Mount Version)	2
33	Strainer (Only for Base Plate Version)	1
34	PTFE Tape	1
35	Hose Clamp (For Base Plate Version)	4
	Hose Clamp (For Drum Mount Version)	2
36	Combo Hose - 4 Metre (For Base Plate Version)	1
37	Base Plate (Only for Base Plate Version)	1
38	Suction Tube (Only for Drum Mount Version)	1
39	Nozzle Holder (Only for Drum Mount Version)	1
40	Bung Adapter (Only for Drum Mount Version)	1
41	Elbow Fitting (Only for Drum Mount Version)	1
42	Hose - 3 Metre (For Drum Mount Version)	1

REPLACEMENT PARTS PROGRAM FOR ELECTRIC DIESEL PUMPS - 12V DC & 24V DC Table 3

REFERENCE NO.	PART NO.	PART DESCRIPTION
26	GLND/FPM-12	Plastic Gland
27	PCLE/EDP-12	Battery Cable
28	SA/FCN/S/3-4/FPM/N	Fuel Control Nozzle
33	STNR/EDP-12	Strainer (Only in Base Plate Version)

SERVICE PARTS PROGRAM FOR ELECTRIC DIESEL PUMPS - 12V DC & 24V DC Table 4

KIT PART NO.	KIT DESCRIPTION	CONSTITUENT PART NO.	PART DESCRIPTION	SUPPLY CONDITION	QTY. PER KIT
KIT/RPR/EDP	Vane Kit	SEL/EDP-12	Seal	As a set	1
		WSR/BDY/EDP	Rubber Washer (Housing)		1
		VANE/EDP-12	Vane		5
		KEY/EDP-12	Key		1

TROUBLESHOOTING
(Refer to EXPLODED VIEW - Page 6)

Table 5

PROBLEM	POSSIBLE CAUSE	SOLUTION
The motor runs but the pump will not prime	The motor is rotating in the wrong direction (the battery terminals are reversed)	Reconnect the RED clamp to (+) terminal & BLACK clamp to (-) terminal of battery
	The Bypass Valve (11) is dirty / sticky	Inspect Spring (10) & Bypass Valve (11). Clean / replace if required
	There is an air leak in the Suction Tube (38) or fuel leakage from threaded joints	Inspect Suction Tube (38), hoses, joints and re-seal with PTFE Tape (34) if required
Pump discharge is low	Low supply voltage	1. Clean the battery clamps & terminals. Ensure that the supply voltage is 12V or 24V as per the pump model 2. Check wear & tear of Magnet Assembly (14), Armature Assembly (15) & Carbon Brush Assembly (18). Replace defective parts
	The tank is not vented	Ensure that the tank is vented to atmosphere
	There is an air leak in the Suction Tube (38) or fuel leakage from threaded joints	Inspect Suction Tube (38), hoses, joints and re-seal with PTFE Tape (34) if required
	The Fuel Control Nozzle (28) or suction line is blocked	1. Ensure that the strainer / filter / hose / nozzle is clean 2. Ensure that the Suction Tube (38) is at least 25 mm above the bottom of tank & fuel level is not too low
The motor stalls when the nozzle is closed	Low supply voltage	1. Clean the battery clamps & terminals. Ensure that the supply voltage is 12V or 24V as per the pump model 2. Check motor & replace if it is faulty
	The Bypass Valve (11) is dirty / sticky	Inspect Spring (10) & Bypass Valve (11). Clean / replace if required
	Sticking Vanes (4)	Ensure the Vanes (4) slide freely inside the Rotor (6). Replace Vanes if required
The switch will not turn ON the pump	Blown fuse	Open fuse cover located in Battery Cable (26). Replace blown fuse (15 Amp)
	Defective Rocker Switch (25)	Check Rocker Switch (25) and replace it if faulty as per the following steps: 1. Loosen three Slotted Head Screws (24). 2. Remove Switch Cover (23) after disconnecting the coupler attached to it. Grab the locking clips of Rocker Switch & push outwards to remove it.
	Damaged or defective motor	Check wear & tear of Magnet Assembly (14), Armature Assembly (15) & Carbon Brush Assembly (18). Replace motor assembly if needed.
Fuel leakage	Pump operating time extended with nozzle closed	Do not exceed 5 minutes of operation with nozzle closed
	Armature shaft worn from Rotor side	Replace Motor Assembly
Motor overheating	Sticking Vanes (4) or Rotor (6) binding	Check to make sure Vanes & Rotor turn freely on shaft
	Pump operating time extended with nozzle closed	Do not exceed 5 minutes of operation with nozzle closed
	The Fuel Control Nozzle (28) or suction line is clogged	Inspect and clean if required
	Pump operated for more than 30 minutes continuously	Limit operation to 30 minutes per hour

SPECIFICATIONS

Table 6

	12V DC	24V DC
Flow Rate (at pump outlet)	Up to 12 GPM (46 LPM)	
Motor	1/4 HP 12V DC	1/4 HP 24V DC
Amp draw from Battery	16 Amp	9 Amp
RPM	2600	
Duty Cycle	30 mins. On / 30 mins Off	
Internal bypass valve	Yes	
Hose	4m X 3/4" ID - in Base Plate Style 3m X 3/4" ID - in Drum Mount Style	
Pump Inlet	3/4" (F) - in Base Plate Style 1" (F) - in Drum Mount Style	
Pump Outlet	3/4" NPT	
Battery Cable	2 metre	
Safety Fuse	15 Amp	



- Always wear protection gear like safety goggles, gloves, apron, and ear plugs while operating the pump
- Never smoke near the pump. Do not use the pump near a source of spark / open flames
- DO NOT under any circumstances put you fingers inside the pump with the electric power connected. Serious injury can occur.
- Always switch off the motor after use, so that media cannot leak in case any of the pump component fails
- Before switching on the motor, check hoses for sign of wear, leak or loose fittings
- **If the temperature of motor goes above 85°C, the motor stops working for a few minutes. It automatically starts once its temperature falls down to 65°C.**
- When changing the working fluid, at least 1 litre of new fluid should be discarded to avoid mixing of fluids
- Pump should NOT be operated for more than 30 minutes continuously. Wait for 30 Minutes before restarting the pump
- Before attempting any maintenance or repair of this product, disconnect power supply and then squeeze Nozzle trigger to release any built up pressure from hose / pump
- Use only genuine factory parts for repair

WETTED COMPONENTS

Steel, Aluminum, Zinc, Cast Iron*, Nylon, Nitrile Rubber & PVC Nitrile

*Only for Drum Mount version

RECOMMENDED USE

Diesel & Kerosene

DO NOT USE WITH

Fluids with a flash point below 100°F (38°C), such as Gasoline & Alcohol

Sparking could result in explosion causing fatal injury



Groz Engineering Tools (P) Ltd.
Groz Net Industries

Village Kherki Daula, National Highway-8
Gurgaon-122001, Haryana, INDIA
TEL +91.124.282.7700 / 221.4050
FAX +91.124.2827986 / 221.4224
FAX (USA) +1.509.271.7848
FAX (UK) +44.870.121.1854

E-MAIL info@groz-tools.com
URL www.groz-tools.com

The Groz name, Groz logo and the mark are trademarks of Groz Engineering Tools (P) Ltd. India